

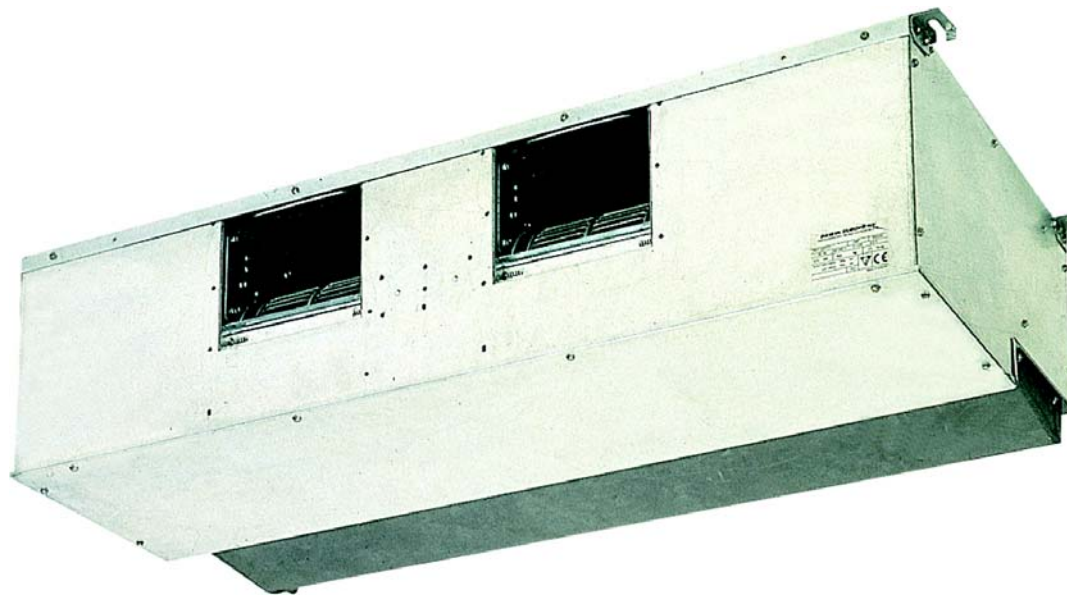

Air Conditioning Technical Data

Concealed ceiling unit with high ESP



EEDEN15-100

FDQ-B

TABLE OF CONTENTS

FDQ-B

1	Features	2
2	Specifications	3
	Technical Specifications	3
	Electrical Specifications	3
3	Options	5
4	Dimensional drawings	6
5	Piping diagrams	7
6	Wiring diagrams	8
	Wiring Diagrams - Single Phase	8
7	Sound data	9
	Sound Power Spectrum	9
	Sound Pressure Spectrum	10
8	Fan characteristics	11
9	Installation	12
	Installation Method	12

1 Features

ESP up to 250, ideal for extra large sized spaces

- High external static pressure up to 250Pa facilitates using flexible ducts of varying lengths
- Discretely concealed in the ceiling: only the suction and discharge grilles are visible
- Up to 26.4kW in heating mode

1

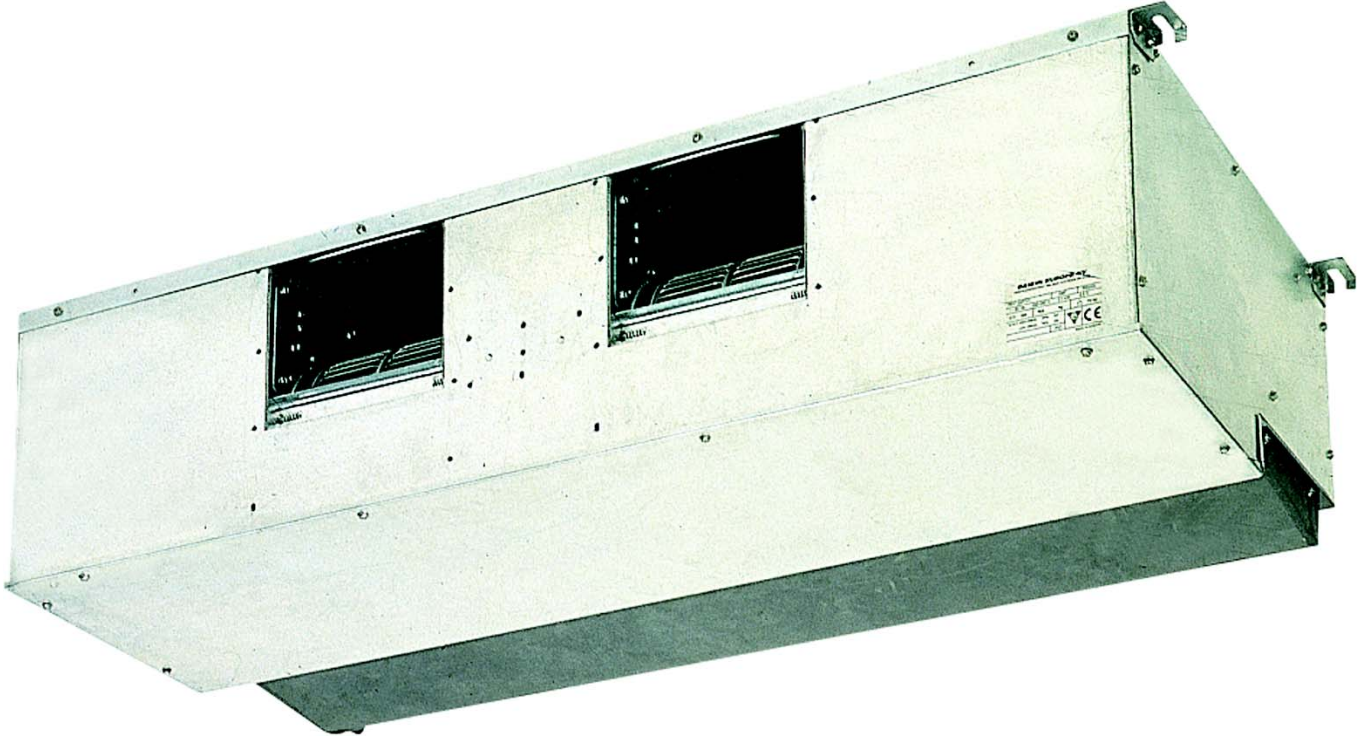

Home leave operation



Fan only



Auto cooling-heating changeover



Fan speed steps



Dry programme



Air filter



Weekly timer



Wired remote control



Centralised control



Auto-restart



Self diagnosis

2 Specifications

2-1 Technical Specifications					FDQ200B		FDQ250B		
Power input - 50Hz	Cooling	Nom.	kW		1,340				
	Heating	Nom.	kW		1,340				
Casing	Colour				Unpainted				
	Material				Galvanised steel				
Dimensions	Unit	Height/Width/Depth	mm		450/1,400/900				
	Packed unit	Height/Width/Depth	mm		607/1,515/1,055				
Required ceiling void >			mm		450				
Weight	Unit		kg		89.0		94.0		
	Packed unit		kg		108.0		113.0		
Heat exchanger	Length		mm		1,200				
	Rows	Quantity			3				
	Fin pitch		mm		2.00				
	Passes	Quantity			12				
	Face area		m ²		0.634				
	Stages	Quantity			24				
	Empty tubeplate hole	Quantity			0				
	Tube type				ø8 Hi-XSS				
	Fin	Type			Non-symmetric fin				
		Treatment			Hydrophilic				
Air filter	Type				Resin net with mold resistance				
Fan	Type				Sirocco fan				
	Quantity				2				
	Air flow rate	Cooling	Nom.	m ³ /min		69.0		89.0	
		Heating	Nom.	m ³ /min		69.0		89.0	
	External static pressure	High	Pa		250				
		Nom.	Pa		250				
Low		Pa		250					
Fan motor	Quantity				1				
	Model				DPC241-241NB				
	Drive				Direct drive				
	Speed	Steps			3		2		
	Output	High	W		650		1,000		
Sound power level	Cooling		dBA		81		82		
	Heating		dBA		-				
Sound pressure level	Cooling	High	dBA		45.0		47.0		
	Heating	Low	dBA		45.0		47.0		
Control systems	Wired remote control				BRC1D52 / BRC1E52A/B				
Refrigerant	Type				R-410A				
Piping connections	Liquid	Type/OD	mm		Flare connection/9.52		Flare connection/12.7		
	Gas	Type/OD	mm		Braze connection/22.2				
	Drain				25				
	Heat insulation				Both liquid and gas pipes				
Temperature control				Microprocessor thermostat for cooling and heating					
Air direction control				Up and downwards					
Safety devices	Item	01		Fan motor thermal fuse					

Standard Accessories : Installation and operation manual; Quantity : 1;

2-2 Electrical Specifications					FDQ200B		FDQ250B	
Power supply	Name				V3			
	Phase				1~			
	Frequency		Hz		50			
	Voltage		V		230			

2 Specifications

2-2 Electrical Specifications			FDQ200B	FDQ250B
Voltage range	Min.	%	-10	
	Max.	%	10	
Current - 50Hz	Zmax	List	No requirements	
Power supply intake			Both indoor and outdoor unit	

2

Notes

Sound values are measured in a semi-anechoic room with corrections.

The sound pressure level is measured via a microphone at 1m distance of the unit.

Sound pressure level is a relative value, depending on the distance and acoustic environment. For more details, please refer to the sound level drawings.

The sound power level is an absolute value indicating the power which a sound source generates.

For more details, please refer to wiring diagram, name plate and installation manual.

3 Options

3 - 1 Options

FDQ-B

Operation control

No.	Item	Type	FDQ200/250B
1	Remote control	Wired	BRC1D52 / BRC1E52A7 (*4) / BRC1E52B7 (*5)
		Infrared	BRC4C65 BRC4C66
2	Simplified remote control (with operation mode selector button)		BRC2E52C7 (*7)
3	Simplified remote control (without operation mode selector button)		BRC3E52C7 (*7)
4	Optional PCB for external electric heaters, humidifiers and/or hour meters		EKRP1B2A (*1) (*2) (*3)
5	Adapter for wiring (interlock for fresh air intake fan)		KRP1B54 (*3)
6	Wiring adapter for electrical appendices		KRP4A51 (*3)
7	Remote sensor		KRCS01-4B
8	Central remote control		DCS302C51
9	Unified ON/OFF controller		DCS301B51
10	Schedule timer		DST301B51
11	Remote "ON/OFF" and "forced OFF" kit		EKRORO
12	Mounting plate for adapter PCB		KRP4A96
13	Interface adapter for the Sky Air series		DTA112B51
14	Digital input adapter		BRP7A54 (*3) (*6)

NOTES

- Electric heaters and humidifiers are field-supplied. Do not install them inside the equipment (refer to installation manual EKRP1B2A).
- When installing electric heaters, an optional PCB for external electric heaters (EKRP1B2A) is required for each indoor unit.
- These options require mounting plate KRP4A96.
Maximally 2 optional PCBs can be mounted.
- Included languages are: English, German, French, Dutch, Spanish, Italian, Greek, Portuguese, Russian, Turkish and Polish.
- Included languages are: English, German, Albanian, Bulgarian, Croatian, Czech, Hungarian, Romanian, Serbian, Slovak and Slovenian.
- Only possible in combination with simplified remote control BRC2/3E52C7.
- Included languages are:
Language pack 1: English, German, French, Dutch, Spanish, Italian and Portuguese.
With PC cable EKPCAB3 in combination with the Updater PC software, you can additionally change the language to:
Language pack 2: English, Bulgarian, Croatian, Czech, Hungarian, Romanian and Slovenian.
Language pack 3: English, Greek, Polish, Russian, Serbian, Slovak and Turkish.

3TW22809-1K

4 Dimensional drawings

4 - 1 Dimensional Drawings

4

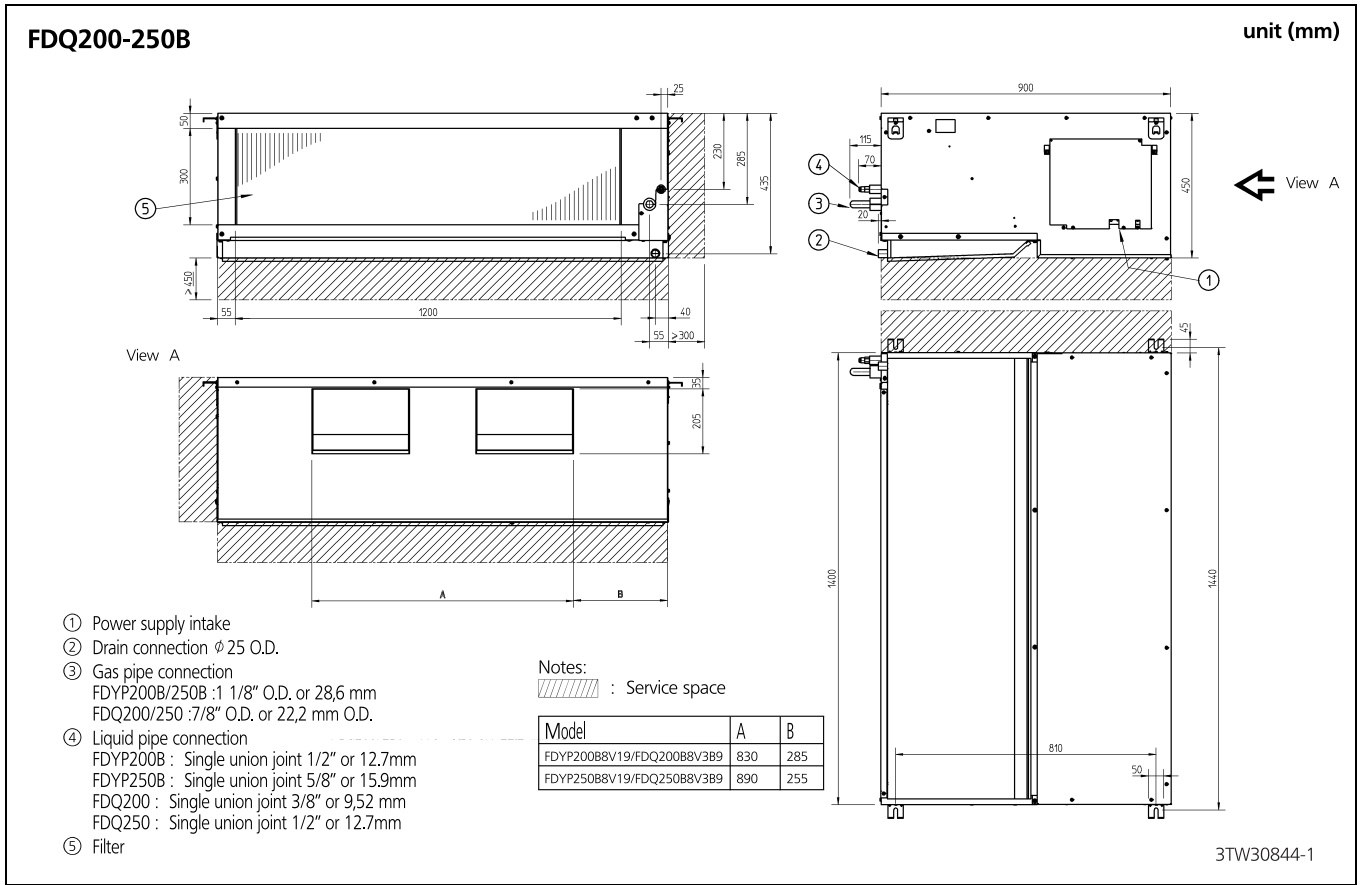

5 Piping diagrams

5 - 1 Piping Diagrams

FDQ125-250B

Refrigerant flow

Cooling 
 Heating 

Refrigerant pipe connection port diameters

Model	Gas	Liquid
FDQ125	φ 15.90	φ 9.52
FDQ200	φ 22.2	
FDQ250		φ 12.7

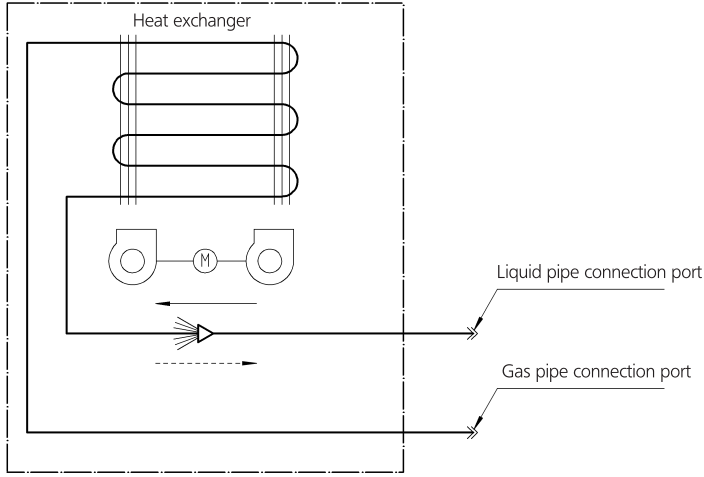

 Check valve  Flare connection  Screw connection  Flange connection  Pinched pipe  Spinned pipe

3TW26055-1A

6 Wiring diagrams

6 - 1 Wiring Diagrams - Single Phase

6

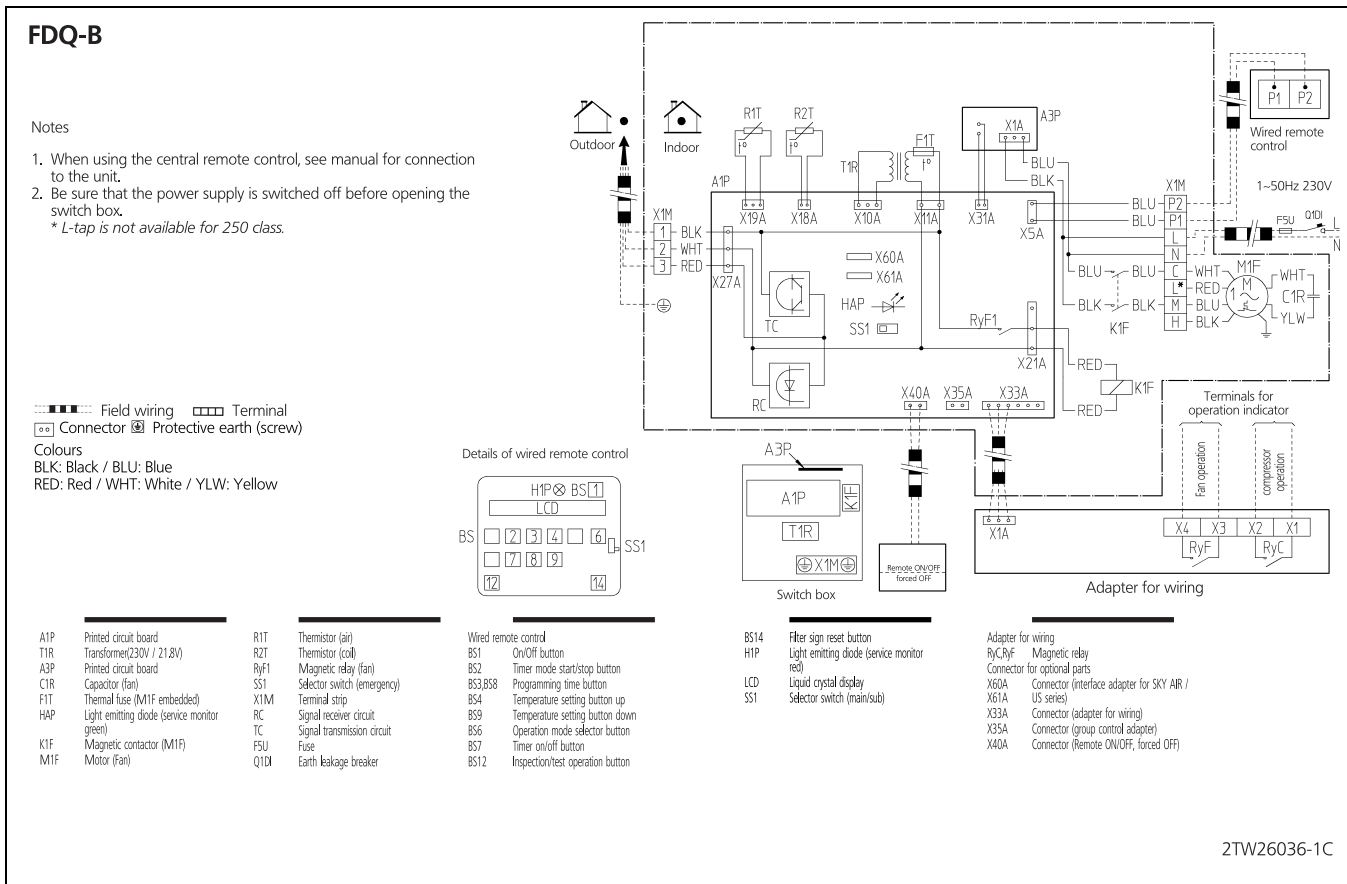

8

7 Sound data

7 - 1 Sound Power Spectrum

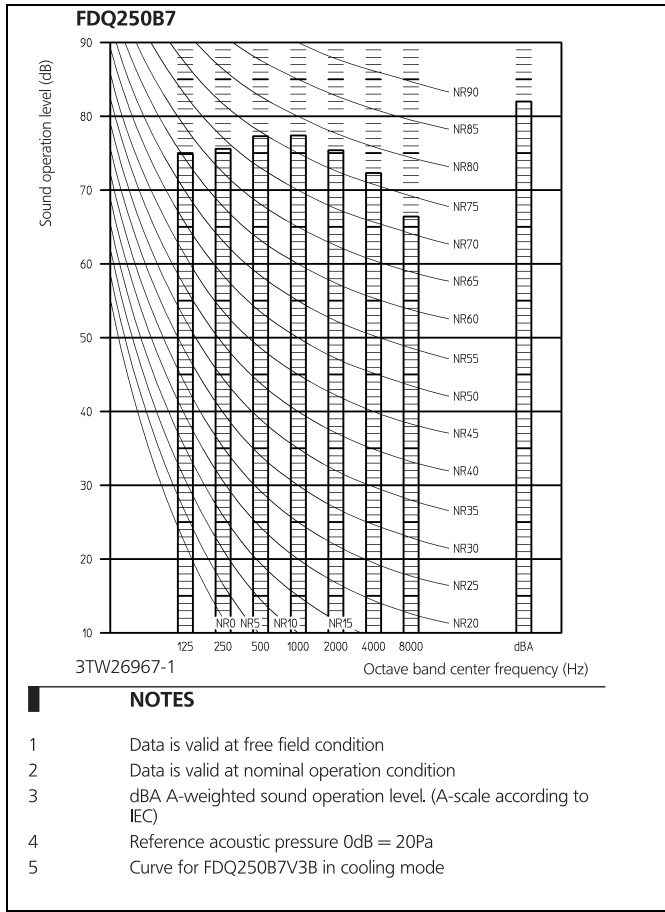
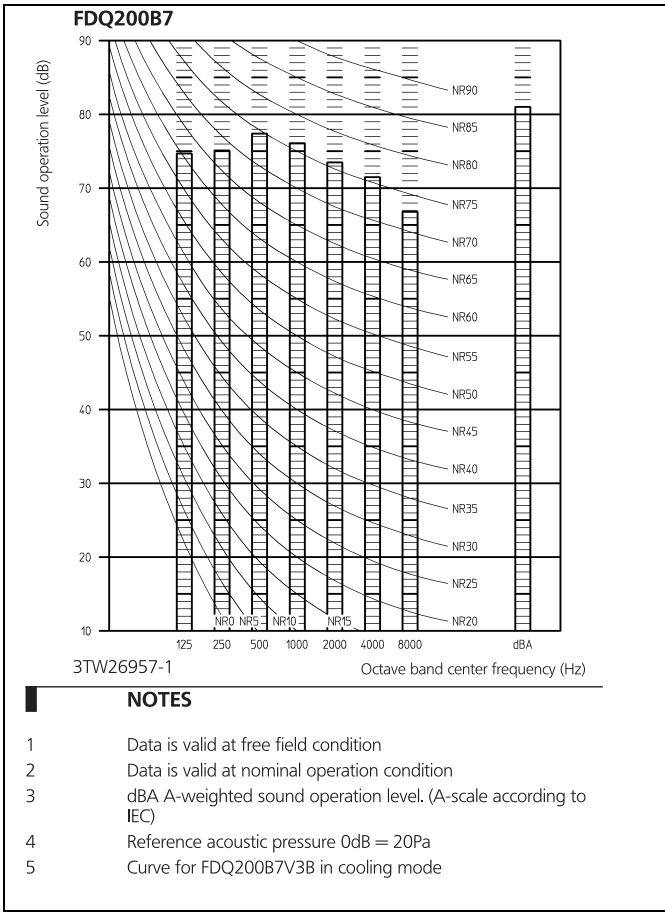

7 Sound data

7 - 2 Sound Pressure Spectrum

7

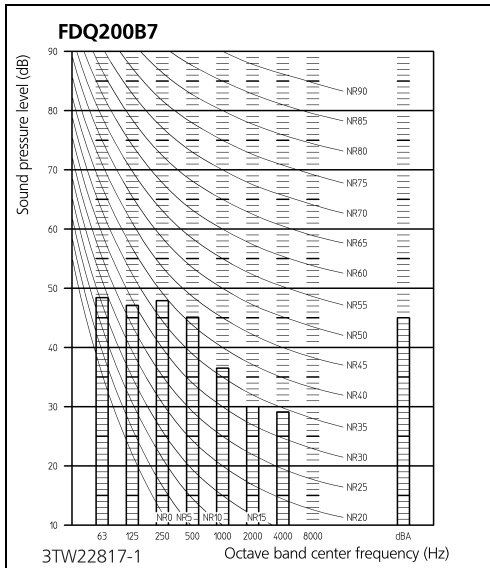

NOTES

- 1 Data is valid at free field condition
- 2 Data is valid at nominal operation condition (50 Pa ESP, 72m³/min)
- 3 dB(A) = A-weighted sound pressure level (A-scale according to IEC)
- 4 Reference acoustic pressure 0dB = 20Pa
- 5 the indicated sound pressure is the casing radiated sound pressure.

Metalducts insulated inside

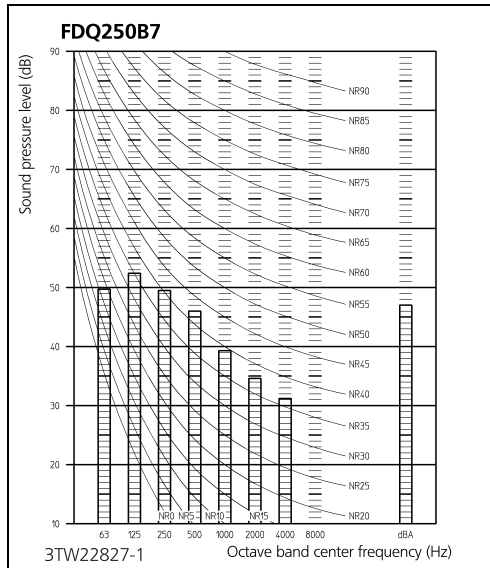
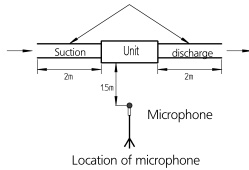

NOTES

- 1 Data is valid at free field condition
- 2 Data is valid at nominal operation condition (62 Pa ESP, 90m³/min)
- 3 dB(A) = A-weighted sound pressure level (A-scale according to IEC)
- 4 Reference acoustic pressure 0dB = 20Pa
- 5 the indicated sound pressure is the casing radiated sound pressure.

Metalducts insulated inside

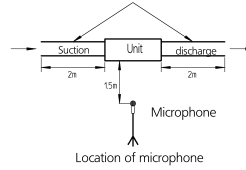

8 Fan characteristics

8 - 1 Fan Characteristics

Fan curve FDQ200B7

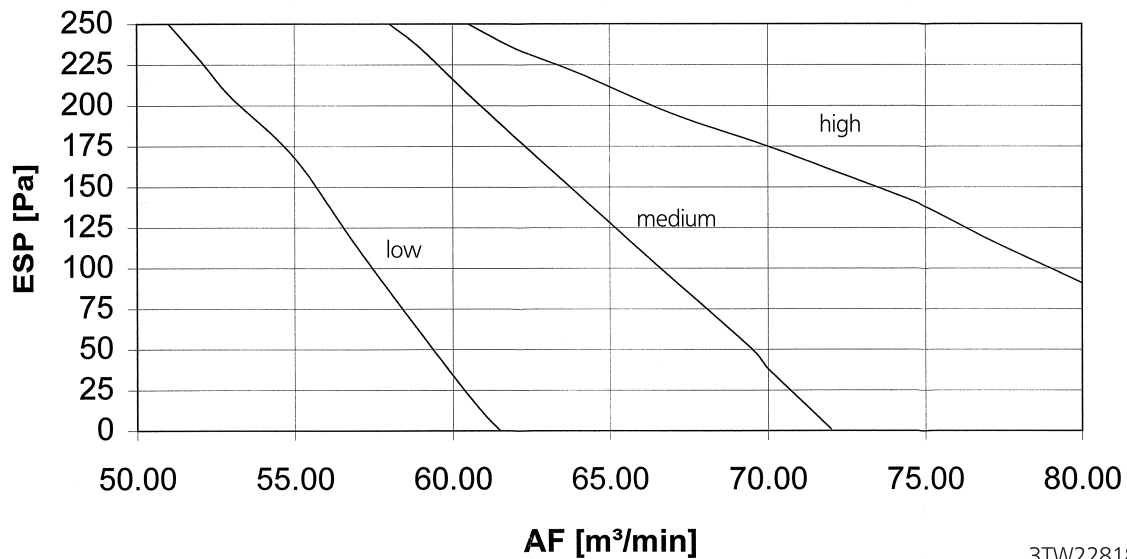

3TW22818-1

Fan curve FDQ250B7

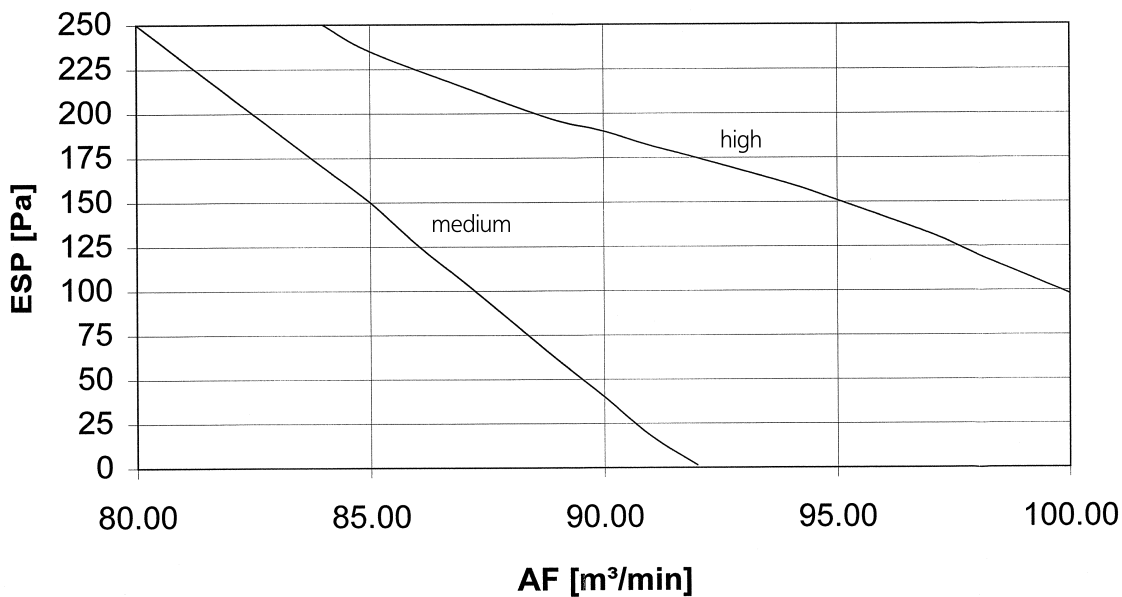

3TW22828-1

9 Installation

9 - 1 Installation Method

9

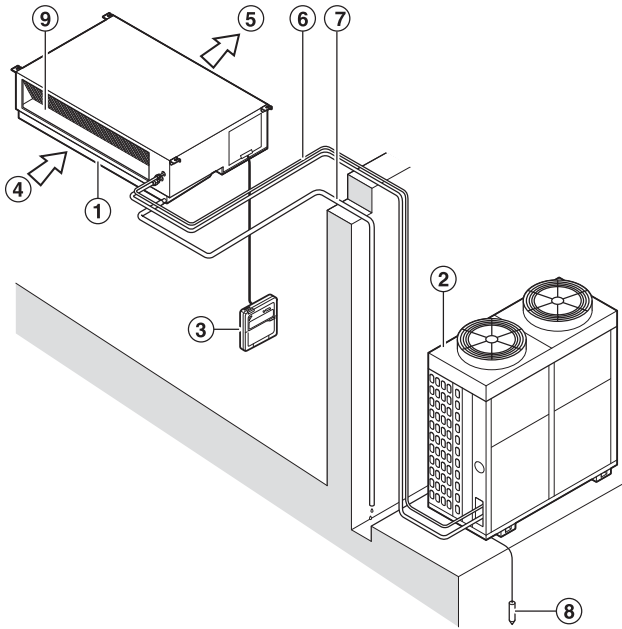

Number	Description
1	Indoor unit
2	Outdoor unit
3	Remote control
4	Inlet air
5	Discharged air
6	Refrigerant piping, connection electric wire
7	Drain pipe
8	Ground wire Wire to ground from the outdoor unit to prevent electrical shocks.
9	Air filter



Daikin Europe N.V. participates in the Eurovent Certification programme for Liquid Chilling Packages (LCP), Air handling units (AHU), Fan coil units (FCU) and variable refrigerant flow systems (VRF) Check ongoing validity of certificate online: www.eurovent-certification.com or using: www.certiflash.com

The present leaflet is drawn up by way of information only and does not constitute an offer binding upon Daikin Europe N.V.. Daikin Europe N.V. has compiled the content of this leaflet to the best of its knowledge. No express or implied warranty is given for the completeness, accuracy, reliability or fitness for particular purpose of its content and the products and services presented therein. Specifications are subject to change without prior notice. Daikin Europe N.V. explicitly rejects any liability for any direct or indirect damage, in the broadest sense, arising from or related to the use and/or interpretation of this leaflet. All content is copyrighted by Daikin Europe N.V.

BARCODE

Daikin products are distributed by: